

# Wacky Kiddie Korner / Kiddie Korner

**Congratulations on your purchase of the Wacky Kiddie Korner and Kiddie Korner.**

Cutting-Edge-Creations, Inc. knows that you'll get many hours of excitement from your new purchase. Please read this booklet carefully, being sure to read all of the safety precautions and the do's and don'ts of the ride.

Remember to stake (tether) your Kiddie Korner as described in the "Installation and Setup" booklet, and be sure to have a minimum of (1) trained operator as defined in the booklet.

Once again, we thank you for doing business with us, and call us if you have any questions.

Sincerely,  
Cutting-Edge-Creations, Inc.



Cutting-Edge-Creations, Inc.

920 Apollo Road, Suite 100  
Eagan, MN 55121 USA

Toll Free 1-800-811-7002 • Local 651-209-8600 • Fax 651-209-8630  
[www.cuttingedgecreations.com](http://www.cuttingedgecreations.com)

WACKY KIDDIE KORNER #K050103 / KIDDIE KORNER #K050101

## KIDDIE KORNER

H W L  
12' x 23' x 26'

1-Piece Unit includes: (2) 1 hp blower w/ log roll, eliminator walls, (2) giant deflation zippers, tether kit: (1) top tethers, (5) bottom tethers, mattress reinforcement strips and carrying bag. Recommended load: (4) patrons over 34" tall, maximum height not to exceed 60" tall, 150 lbs. suggested maximum weight per patron.

This Unit Requires **2** Blower(s) to Function Properly.

CEC Suggests the following Blower Types:

- Tool King™ Air Eagle High Volume Output ..... 1.0-1.5 hp; 810 CFM

All information included in this supplement is kept current and up-to-date. Cutting Edge Creations, Inc. reserves the right to update this information from time to time as needed.

### ! Safety Notice !

All materials have been tested and comply to NFPA 701 Large Scale Test. All units meet the requirements under ASTM F 698-94, ASTM F 770-93 and ASTM 2374-07A. Safety and Maintenance Manuals are included with this unit. Minimum CFM requirement for this inflatable is 810 CFM.

Recommended Number of Installers	Number of Operators	Maximum Number of Patrons
<b>2</b>	<b>1</b>	<b>4</b>
Suggested Max Weight per Patron <b>150 lbs.</b>	Use Whistle for Control	
		Total Patron Weight <b>600 lbs.</b>

Minimum & Maximum Height	No. of Stakes & Minimum Stake Length	Indoor Weight Container Anchors	Outdoor Hard-Surface Anchors*
34" Min. 60" Max.	<b>(6) 40" Long</b>	<b>(6) 300 lbs.</b>	<b>(6) 600 lbs.</b>
	75% Buried	50 lbs. Per Container	100 lbs. Per Container

**ALL OUTDOOR USE MUST USE GROUND STAKES!**  
\* All outdoor weight containers **MAY NOT** comply with all state or municipal tethering requirements for inflatable devices.

**! ALWAYS** contact the utility company before pounding stakes into the ground! **!**



### SAMPLE WARNING LABEL

A Warning Label is placed on every inflatable that Cutting Edge Creations produces. The image shown above is only a *sample* of the Warning Label found on the side of your inflatable, and may not represent the information pertinent to the safety of this particular unit.

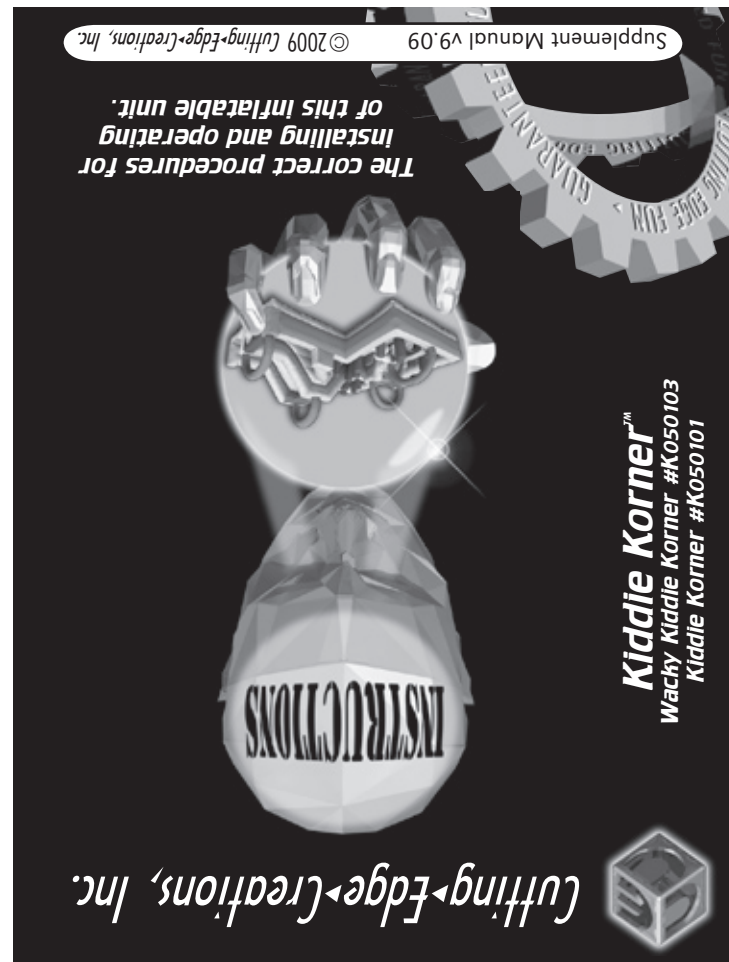

**Catastrophe!**  
This type of catastrophe can always be avoided by proper tethering, utilizing 40" long ground stakes, and by having trained operators on duty and avoiding inclement weather (such as high winds i.e. winds in excess of 20 m.p.h.).

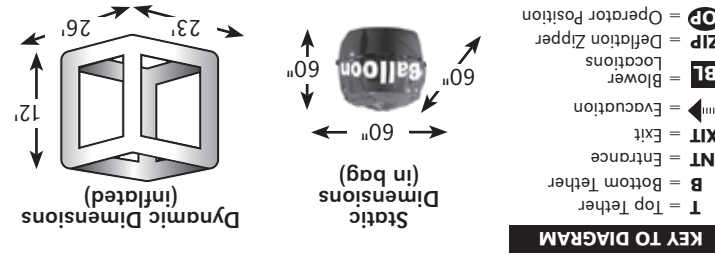

### NEVER LEAVE THIS RIDE UNATTENDED!

- Read instruction booklet.
- Remove unit from storage bag.
- Position on a level ground area approximately 29' x 32'.
- Install ground stakes, at least **(6)** around perimeter.
- Loosely tie the tethers to ground stakes.
- Attach **(2)** blower(s) to tubes, making sure Velcro strap is firmly secure.
- Close zippers & flaps on all locations of unit and make sure they are secure.
- Connect each blower to its own power source. Keep in mind that each blower used will require a constant supply of 110-volt, 20-amp power.
- Turn blower system on and guide the unit until it is fully inflated.
- Secure all tethers after the unit is fully inflated.
- Do a safety check of blowers, slide & climb covers.
- Do not operate this unit in winds in excess of 20 mph.

### Directions

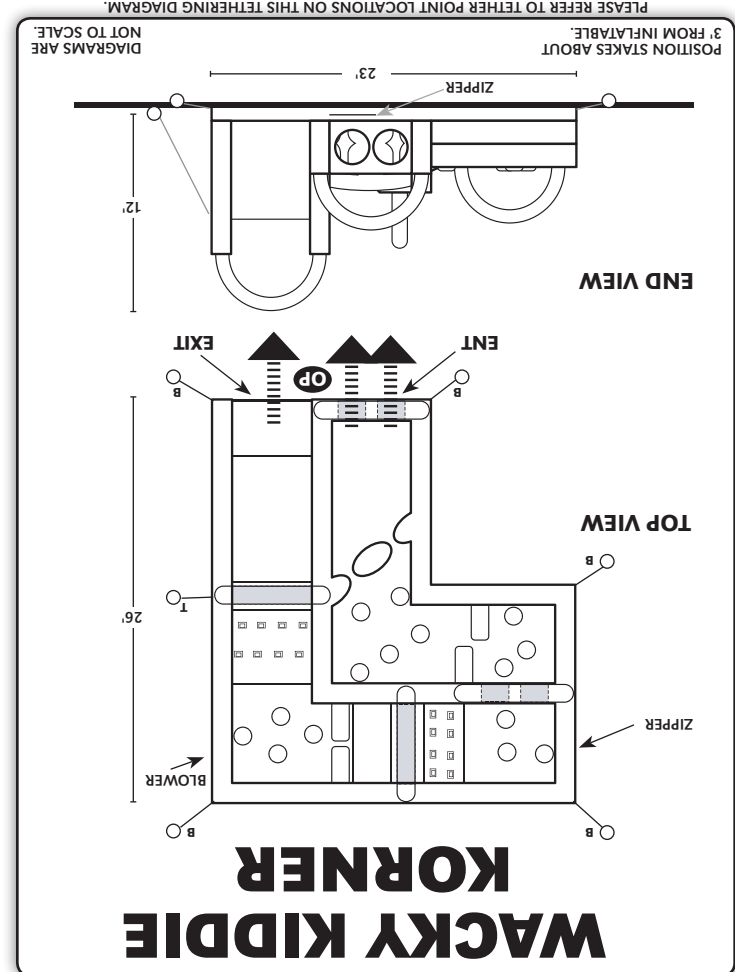

**Improper use of this inflatable may cause serious injury!**

Operator Take Control...  
**Use Whistle!**

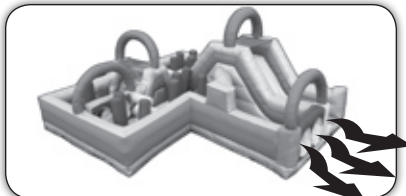

**Evacuation Procedures!**

The blower tube has an automatic air flap that reduces the loss of air if the blower system goes off. In the event of a power outage or emergency take-down, direct patrons off the inflatable as shown by arrows in the diagram shown above.

**ASTM Standard #F7324-06 6.6.1**  
Operators & attendants shall incorporate the use of whistles or other devices or signal equipment & take appropriate action at the first sign of misbehavior or violation of posted rules.

**Make sure all operators understand the proper procedures for using this inflatable, and that passengers must follow the rules.**

**Deflation Rate of Inflatable:**

Type of Testing: Observed  
Deflation Rate to unsafe conditions: 3-5 minutes.



**Avoid Contact with Others!**

Passengers must be instructed to use or ride unit individually. Do NOT allow double riding, as accidents WILL happen!



**Do Not Hit Your Head!**

DO NOT dive or enter unit head first, as head or neck injuries may occur!



**Keep Landing Areas Clear!**

Operators should not allow participants to land on one another. Accidents WILL happen!



**Instruct Safety!**

Instruct riders to follow the safety rules located on entrance side of unit. NO flipping or jumping, as injuries may occur!



**Watch Out for High Temps!**

DO NOT operate when temperatures exceed 90-degrees. Watch for early signs of heat exhaustion and for dehydration.

**Important!**

**Use and Indemnification:**

"Buyer" (person, company or entity purchasing the inflatable product or device), is solely responsible for the manner of use of the products and other equipment purchased from Cutting Edge Creations, Inc. "Buyer" is solely responsible for all signage, labels and warnings to consumers or other users of the products and equipment, and for any and all other acts necessary, including user warnings and limitations (e.g., weight, height, age, number of participants and medical condition limitations), to ensure the safety of the users. "Buyer" acknowledges that they have received, read and fully understand all necessary instructions for the safe setup and operation of their Cutting Edge Creations, Inc. inflatable product or device. "Buyer" agrees to operate their Cutting Edge Creations, Inc. inflatable product or device according to the instructions established by Cutting Edge Creations, Inc. "Buyer" agrees to operate their inflatable product or device according to all state and local requirements. "Buyer" agrees to train any person(s) operating the inflatable product or device in the safe operation of the inflatable product or device including safe handling of emergency situations. "Buyer" shall use proper stakes, tie-downs, and other applicable devices necessary to ensure the safety of users and the general public. "Buyer" agrees to indemnify, defend and hold harmless Cutting Edge Creations, Inc. and Cutting Edge Creations, Inc. Insurers from actions and claims of third parties, including customers of "Buyer" and users of the goods and products sold to "Buyer", arising out of or in connection with the use of the goods and products herein described or resulting from the breach of the provisions in this Confirmation of Order by "Buyer". In the event Cutting Edge Creations, Inc. is required to commence an action to enforce this provision, "Buyer" shall pay all of Cutting Edge Creations, Inc. legal costs and expenses.

**Step by Step Procedure: Wacky Kiddie Korner**



1. Enter unit feet first through the left or right entrance hole.

**NO DIVING!**



2. Push yourself through the vertical squeeze play. No Diving!



3. Push your way past the tackle dummies and push tubes.



4. Climb feet first through the next hole. No Diving!



5. Push your way past the next set of tackle dummies.



6. Climb up the next hill to the slide, using the safety handles!



7. With arms crossed, slide down the hill feet first. No Diving!



8. Push your way past the remaining push tubes and tackle dummies.



10. Climb up the next hill to the slide, using the safety handles!



11. With arms crossed, slide down the hill feet first. No Diving!

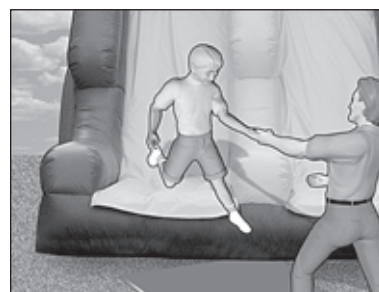

12. Exit the unit with the help of the operator.

**PATH OF PATRONS THROUGH KIDDIE KORNER**

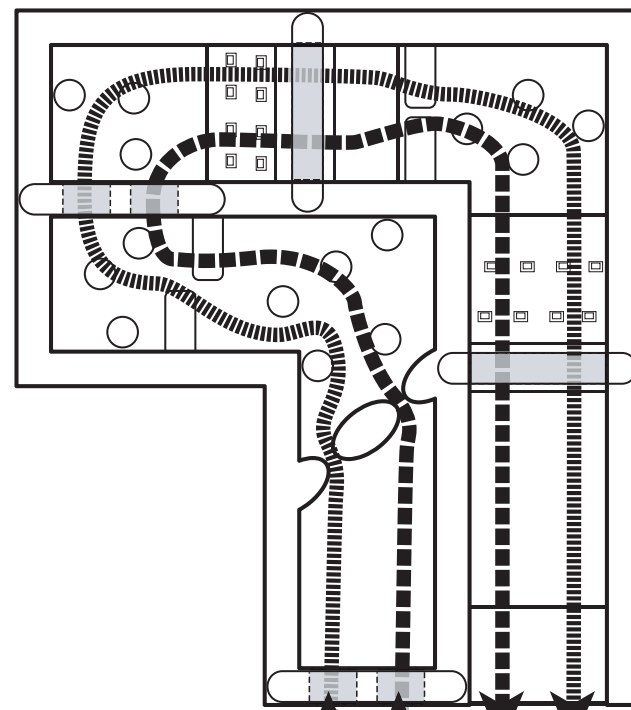

**DAILY INSPECTION CHECKLIST OF INFLATABLE**

- Check to see if blower(s) is attached properly and securely to inflatable device.
- Make sure all deflation zippers are closed and secured.
- Check blower electric attachment to be sure it has been properly plugged in to receptacle.
- Make sure blower system has no obstruction restricting intake on sides of blower.
- Check inflation of unit to be sure it is properly inflated to correct firmness.
- Make adjustments to slide and climb covers if necessary to proper secure position.
- Make sure all tether points are attached properly.
- Check netted areas and sun covers to be sure they are in place and in good condition.
- Crawl through (if possible) inflated device and examine all visible seams for stretching or wear. If problems with any seams contact manufacturer to advise.

ADVERTISEMENT

**WATCHDOG BLOWER-SIREN™**

The Watchdog™ blower siren is the future for safer operation of inflatable amusement rides.

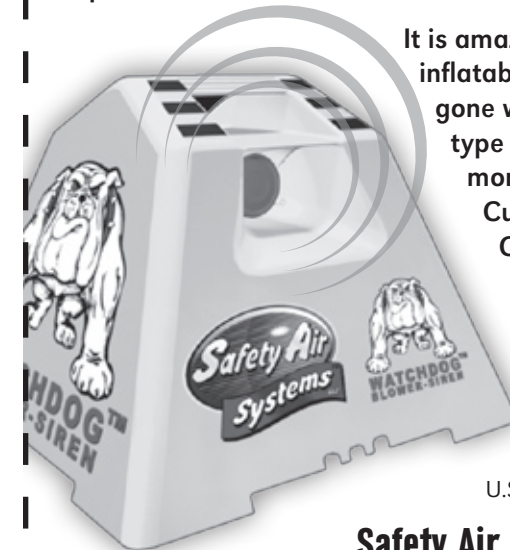

It is amazing that the inflatable industry has gone without any type of device for monitoring inflation. Cutting Edge Creations, Inc., is a licensed provider of the Watchdog Blower Siren.

WATCHDOG™ pods are only available in 110v.

U.S. Patent #6,650,246



**Safety Air Systems, LLC**  
info@safetyairsystems.com  
www.safetyairsystems.com

ADVERTISEMENT